

Nettco S-Series Mixer

SANITARY STAINLESS STEEL - PORTABLE/FIXED MOUNT MIXERS



A World Leader In Industrial Mixing Since

1923. Lightnin has over 85 years of unrivaled experience in industrial mixing technology, process knowledge, and technological innovation. Lightnin enjoys a global reputation for durable, long-lasting mixers, agitators, aerators, and flocculators for fluid process systems. We offer a full spectrum of impeller designs for diverse applications. In addition, we offer a worldwide service network, mixer repair, gearbox repair, and replacement parts programs. Look to Lightnin for knowledge, technology and service excellence.

Based in Charlotte, North Carolina, SPX Corporation (NYSE: SPW) is a global, multi-industry manufacturing leader with approximately \$5 billion in annual revenue, operations in more than 35 countries and over 14,000 employees. The company's highly-specialized, engineered products and technologies are concentrated in Flow Technology and energy infrastructure. Many of SPX's innovative solutions are playing a role in helping to meet rising global demand for electricity and processed foods and beverages, particularly in emerging markets. The company's products include food processing systems for the food and beverage industry, critical Flow components for oil and gas processing, power transformers for utility companies, and cooling systems for power plants. For more information, please visit www.spx.com.

Introducing a new economical Portable and Fixed Mount Mixer System configured to meet your sanitary needs

MEETS 3A AND EC 1935:2004 STANDARDS FOR THE FOOD INDUSTRY

The Nettco S-Series sanitary mixer is available in a wide range of mixing and mounting configurations utilizing a unique modular assembly design. With one mixer it is possible to configure a clamp-on, open tank, or sealed mixer design. This mixer can be quickly converted from one mounting arrangement to another. Modifying the mounting configuration can be accomplished in less than two minutes.

- Highest quality at a competitive price
- For new and existing tank sizes: 0.1 - 20 m³ (25 - 5,000 U.S. gal.)
- Designed for Dairy, Beverage, Oil, Prepared Foods and more
- Wide range of impellers and mounting options



UNIQUE MODULAR CONCEPT FEATURES:

- Sanitary, all stainless steel design
 - 304 SS housing
 - Washdown (IP55), inverter ready motor
 - Proven planetary gearing – robust and reliable
 - Food grade lubricant
 - Unique, innovative modular design
 - Reverse-taper shaft attachment for added safety
 - Stainless Steel Motor, 0.37 - 2.2 Kw (1/2 - 3 HP)
 - Optional air motor available
 - Fully standardized product
- Direct and gear options for this global use mixer provides full range of shaft speeds (RPM)
 - 1450, 290, and 240 (50 Hz)
 - 1750, 350, and 280 (60 Hz)
- Shaft lengths up to 2100 mm (84")
- Simple, compact design, 3A and EC 1935:2004 clean design available
- Economical
- Impellers from world's mixing technology leader
 - Multiple style impellers available
 - Hydrofoil, PBT and FP 100 (Marine Props)

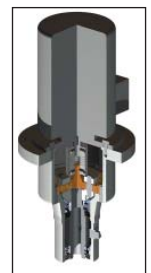

Gear Drive Section View



Direct Drive Section View



Air Motor

MODULAR DESIGN FEATURES:

Clamp Module (P):

- Bolted onto base module
- Clamps to vessel or stand
- 0° to 20° horizontal mounting
- 0° to 90° vertical adjustment

Adjustable mounting - controls vessel contents swirl for improved mixing



Fixed-Mount Open Tank Module (Q):

Open Tank Flange Module

- Attaches to base module
- Use on open tanks where a seal is not required
 - Vertical on center for baffled tanks
 - Vertical offset for unbaffled tanks
 - Can be angular mounted



Bung Adaptor

Allows for mixing in drums by fitting securely into the opening of the lid without the need for clamps or support brackets

- Attaches to base module
- For use on standard drum with a 2" NPT bung
- Stainless Steel construction to prevent corrosion



Fixed-Mount Closed Tank Lip Seal Module (L):

Closed Tank Sealed Module

- Attaches to base module
- For closed tanks with seal requirements
 - ANSI or DIN Flange Mount Lip Seal
 - Food grade lip seal good for 0.3 BAR (5 PSI) (allowable tank pressure)



Sanitary Flange Lip Seal:

Clamps to sanitary tank flanges for a simple, clean connection when a low pressure sealing device is required.

- Attaches to base module
- 3", 4" and 6" Sanitary Flange designs available
- Food grade lip seal good for 0.3 BAR (5 PSI) (allowable tank pressure)
- Stainless Steel construction to prevent corrosion



Fixed-Mount Closed Tank Mechanical Seal Module (S):

Closed Tank Sealed Module

- Attaches to base module
- For closed tanks with seal requirements
 - ANSI or DIN Flange Mount
 - Single dry-running mechanical seal good for 5 BAR (75 PSI) (allowable tank pressure)



Sanitary Flange Mechanical Seal Assembly:

Clamps to sanitary flanges for a simple, clean connection when a mechanical seal is required.

- Attaches to base module
- 3", 4" and 6" Sanitary Flange designs available
- Single dry-running mechanical seal good for 5 BAR (75 PSI) (allowable tank pressure)
- Stainless Steel construction to prevent corrosion



Typical product applications

With an all stainless steel construction and features designed to meet 3-A and EC 1935:2004 standards, the Nettco S-Series mixer can be used in a variety of sanitary mixing applications. And with Lightnin's unparalleled experience, every mixer comes with a process guarantee!

Dairy



Prepared Foods



Beverage



Pharma



Personal Care



MODULAR MIXING SYSTEM:

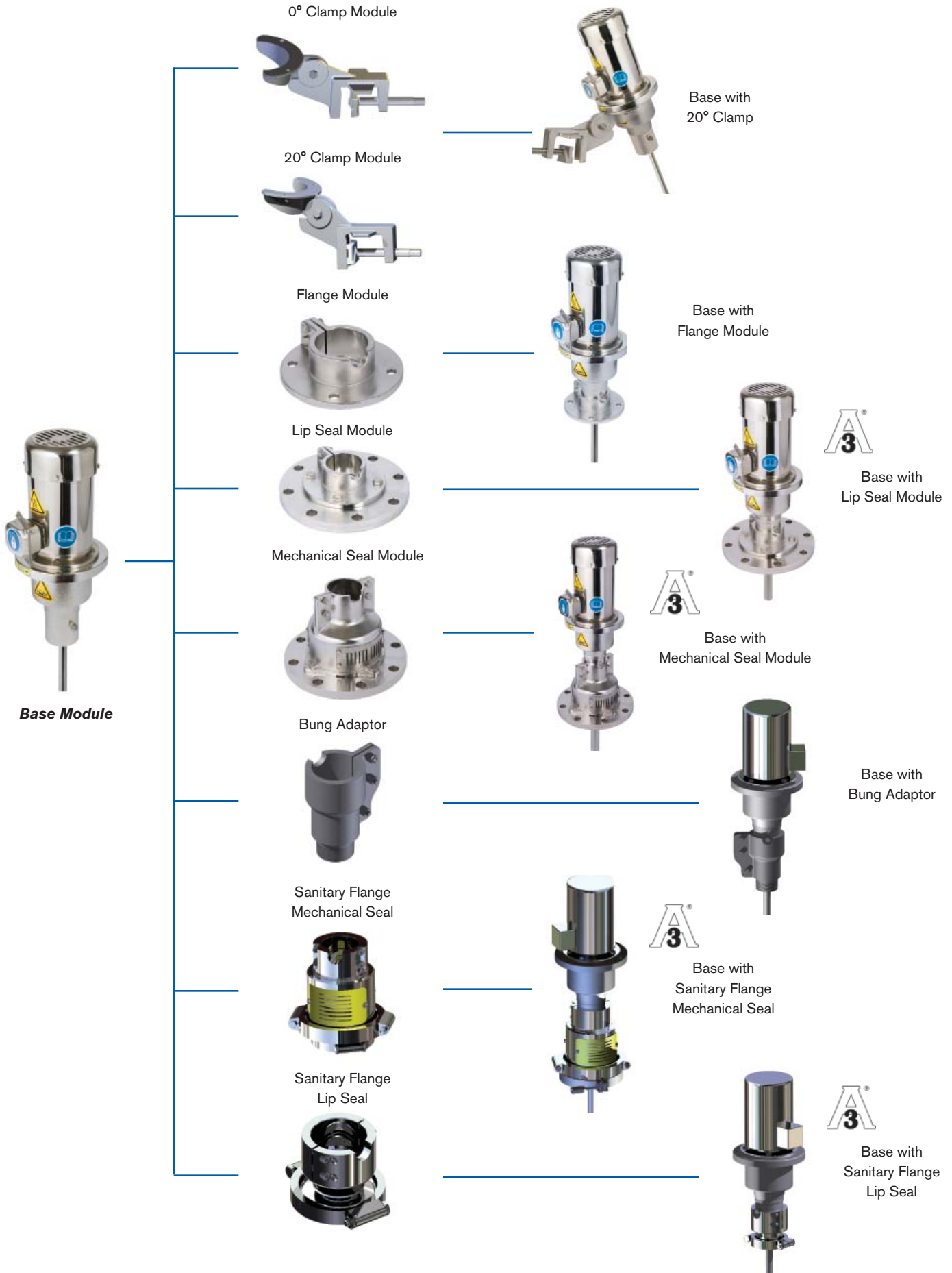

MODEL	MOTOR	WEIGHT (SEE NOTE 3)		A	C	D	E
		KG	LBS				
MS_L1	0.37/0.50	36	80	250 (98.3)	20	103 (41.1)	
MS_L2	0.55/0.75	54	120	299 (118)		130 (51.1)	
MS_L3	0.75/1.00	62	136	368 (133)	25	135 (53.3)	
MS_L4	1.10/1.50	69	153	472 (169)		150 (59)	

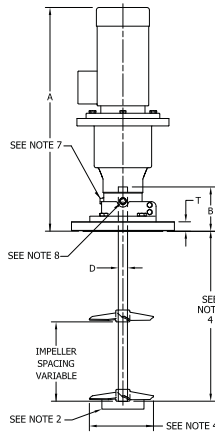
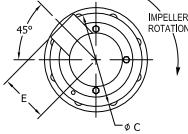

- NOTES:
1. DIMENSIONS ARE FOR REFERENCE ONLY UNLESS CERTIFIED.
 2. LOWER IMPELLER IS EQUIPPED WITH STABILIZER WHEN REQUIRED.
 3. MIXER WEIGHT IS LESS SHAFT AND IMPELLERS.
 4. DEPENDENT UPON SPECIFIC APPLICATION.
 5. STANDARD MOUNTING FLANGE DATA, DIMENSIONS IN MILLIMETERS.
 6. STANDARD MOUNTING FLANGE DATA, DIMENSIONS IN INCHES.
 7. MIXER SHAFT SET SCREW ACCESS FOR MS_L1 UNITS IS ON CENTER WITH THE MIXER MOUNTING SPLIT LINE.
 8. MIXER SHAFT SET SCREW ACCESS FOR MS_L2 THRU MS_L6 UNITS.
 9. NON-STANDARD DIMENSIONS.
 10. FLANGE FINISH, INCLUDING GASKET AREA, IS POLISHED TO 20 Ra

PN10 DRILLING (SEE NOTE 5)						
DN SIZE	O.D.	BOLT CIRCLE	NO. OF HOLES	BOLT DIA. Δ	B	T
100 *	229	180	8	M16	128	33.8
125	250	210	8	M16	112	17.7
150	285	240	8	M20	112	17.7
200	340	295	12	M20	116	21.7

DAIRY FLANGE (SEE NOTES 5 & 9)						
DN SIZE	O.D.	BOLT CIRCLE	NO. OF HOLES	BOLT DIA. Δ	B	T
65*	180	130	4	M8	112	18.0

150LB. ANSI DRILLING (SEE NOTE 6)						
ANSI SIZE	O.D.	BOLT CIRCLE	NO. OF HOLES	BOLT DIA. Δ	B	T
4 *	9	7.50	8	0.63	5.0	1.33
5	10	8.50	8	0.75	4.5	.77
6	11	9.50	8	0.75	4.5	.83
8	13.5	11.75	8	0.75	4.6	.96

Δ BOLT HOLES STRADDLE MIXER CENTERLINE.
* FLANGE SIZES ONLY AVAILABLE ON MS_L1 UNITS.

L UNIT

MODEL	MOTOR	WEIGHT (SEE NOTE 3)		A	B	C	D	E		F		G		H		J		K		L	M	N	O	
		KG	LBS					Max	Min	Offset	Offset	Offset	Offset	Offset	Offset	Offset	Offset	Offset	Offset					Offset
		σ	σ					σ	σ	σ	σ	σ	σ	σ	σ	σ	σ	σ	σ					
MS_P1	0.37/0.50	24	52	312 (12.3)	89 (3.5)	200 (7.9)	123 (4.8)	67 (2.6)	73 (2.9)	37 (1.5)	45 (1.8)	111 (4.4)	119 (4.7)	65 (2.6)	28 (1.1)	45 (1.8)	128 (5.1)	113 (4.5)	235 (9.3)	82 (3.2)	20	105 (4.1)		
MS_P2	0.55/0.75	45	99	411 (16.2)	89 (3.5)	250 (9.8)	147 (5.8)	84 (3.3)	77 (3.0)	46 (1.8)	60 (2.4)	138 (5.4)	152 (6.0)	85 (3.3)	33 (1.3)	49 (1.9)	176 (6.9)	158 (6.3)	260 (10.2)	103 (4.1)	25	130 (5.1)		
MS_P3	0.75/1.00	52	115	411 (16.2)	89 (3.5)	250 (9.8)	147 (5.8)	84 (3.3)	77 (3.0)	46 (1.8)	60 (2.4)	138 (5.4)	152 (6.0)	85 (3.3)	33 (1.3)	49 (1.9)	176 (6.9)	158 (6.3)	260 (10.2)	103 (4.1)	25	135 (5.3)		
MS_P4	1.10/1.50	60	132	411 (16.2)	89 (3.5)	250 (9.8)	147 (5.8)	84 (3.3)	77 (3.0)	46 (1.8)	60 (2.4)	138 (5.4)	152 (6.0)	85 (3.3)	33 (1.3)	49 (1.9)	176 (6.9)	158 (6.3)	260 (10.2)	103 (4.1)	25	150 (5.9)		

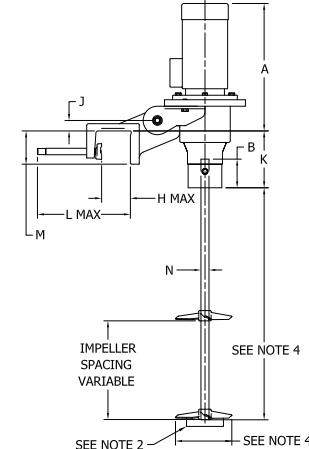
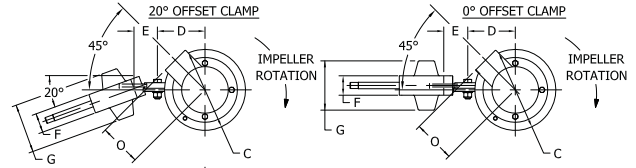

- NOTES:
1. DIMENSIONS ARE FOR REFERENCE ONLY UNLESS CERTIFIED.
 2. LOWER IMPELLER IS EQUIPPED WITH STABILIZER WHEN REQUIRED.
 3. MIXER WEIGHT IS LESS SHAFT AND IMPELLERS.
 4. DEPENDENT UPON SPECIFIC APPLICATION.

P UNIT

MODEL	MOTOR	WEIGHT (SEE NOTE 3)		A	B	C	D	E	F	G	H	J
		KG	LBS									
MS_Q1	0.37/0.50	21	47	429 (16.9)	94 (3.7)	200 (7.9)	51 (2.0)	102 (4.0)	180 (7.1)	10	20	105 (4.1)
MS_Q2	0.55/0.75	40	89	429 (16.9)	94 (3.7)	200 (7.9)	51 (2.0)	102 (4.0)	180 (7.1)	15	25	130 (5.1)
MS_Q3	0.75/1.00	48	105	575 (22.6)	94 (3.7)	250 (9.8)	51 (2.0)	102 (4.0)	180 (7.1)	15	25	135 (5.3)
MS_Q4	1.10/1.50	55	122	575 (22.6)	94 (3.7)	250 (9.8)	51 (2.0)	102 (4.0)	180 (7.1)	15	25	150 (5.9)

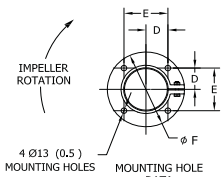
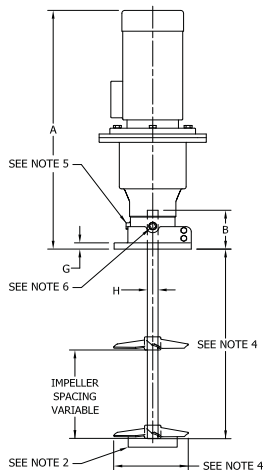
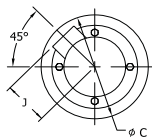

- NOTES:
1. DIMENSIONS ARE FOR REFERENCE ONLY UNLESS CERTIFIED.
 2. LOWER IMPELLER IS EQUIPPED WITH STABILIZER WHEN REQUIRED.
 3. MIXER WEIGHT IS LESS SHAFT AND IMPELLERS.
 4. DEPENDENT UPON SPECIFIC APPLICATION.
 5. MIXER SHAFT SET SCREW ACCESS FOR MS_Q1 UNITS IS ON CENTER WITH THE MIXER MOUNTING SPLIT LINE.
 6. MIXER SHAFT SET SCREW ACCESS FOR MS_Q2 THRU MS_Q6 UNITS.

Q UNIT

MODEL	MOTOR	WEIGHT (SEE NOTE 3)		A	C	D	E
		KG	LBS				
MS_S1	0.37/0.50	40	87	575 (22.7)	300 (7.9)	20	105 (4.1)
MS_S2	0.55/0.75	57	126	699 (27.5)	250 (9.9)	25	130 (5.1)
MS_S3	0.75/1.00	64	142	768 (30.3)	250 (9.9)	25	135 (5.3)
MS_S4	1.10/1.50	72	159	772 (30.4)	250 (9.9)	25	150 (5.9)

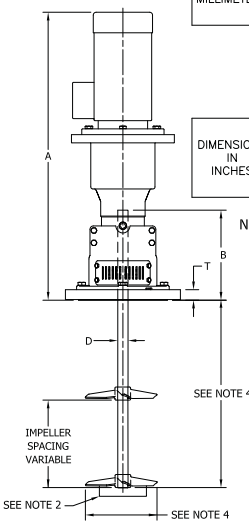
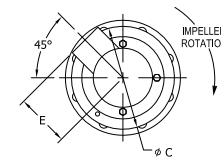

PN10 DRILLING (SEE NOTE 5)						
DN SIZE	O.D.	BOLT CIRCLE	NO. OF HOLES	BOLT DIA. Δ	B	T
100 *	229	180	8	M16	241	33.8
125	250	210	8	M16	225	17.7
150	285	240	8	M20	225	17.7
200	340	295	12	M20	229	21.7

150LB. ANSI DRILLING (SEE NOTE 5)						
ANSI SIZE	O.D.	BOLT CIRCLE	NO. OF HOLES	BOLT DIA. Δ	B	T
4 *	9	7.50	8	0.63	9.5	N/A
5	10	8.50	8	0.75	8.9	8.4
6	11	9.50	8	0.75	9.0	8.5
8	13.5	11.75	8	0.75	9.1	8.6

Δ BOLT HOLES STRADDLE MIXER CENTERLINE.
* FLANGE SIZES ONLY AVAILABLE ON MS_S1 UNITS

- NOTES:
1. DIMENSIONS ARE FOR REFERENCE ONLY UNLESS CERTIFIED.
 2. LOWER IMPELLER IS EQUIPPED WITH STABILIZER WHEN REQUIRED.
 3. MIXER WEIGHT IS LESS SHAFT AND IMPELLERS.
 4. DEPENDENT UPON SPECIFIC APPLICATION.
 5. STANDARD MOUNTING FLANGE DATA, FLANGE FACE, INCLUDING GASKET AREA, IS POLISHED TO 20Ra

S UNIT

MIXER "BLEND TIME SELECTION TABLE"

60 HZ SELECTIONS

		VISCOSITY/cP or mPa-s						
		1	100	250	500	1000	2500	5000
TANK VOLUME / U.S. GALLONS	< 25	MS1_1 (1) 1 3.6 FP	MS1_1 (1) 1 3.6 FP	MS1_1 (1) 1 3.6 FP	MS1_1 (1) 1 3.6 FP	MS1_1 (1) 1 3.3 FP	MS6_1 (2) 1 8.9 FP	MS6_1 (3) 1 7.7 FP
	< 50	MS1_1 (1) 1 3.6 FP	MS1_1 (1) 1 3.6 FP	MS1_1 (2) 1 3.6 FP	MS1_1 (2) 1 3.6 FP	MS5_1 (1) 1 10.0 H	MS6_1 (3) 1 8.9 FP	MS6_1 (3) 1 10.0 FP
	< 100	MS1_1 (2) 1 3.6 FP	MS1_1 (2) 1 3.6 FP	MS1_1 (2) 1 3.8 FP	MS5_1 (1) 1 11.2 H	MS5_1 (2) 1 10.0 H	MS6_1 (3) 1 10.0 FP	MS6_2 (5) 2 10.0 FP
	< 200	MS1_1 (3) 1 3.6 FP	MS1_1 (3) 1 3.6 FP	MS5_1 (1) 1 11.2 H	MS5_1 (2) 1 11.2 H	MS6_1 (3) 2 11.2 H	MS6_2 (6) 2 10.5 FP	MS6_3 (9) 2 10.5 FP
	< 500	MS1_1 (6) 1 3.8 H	MS5_1 (3) 1 11.2 H	MS5_1 (4) 1 11.2 H	MS5_1 (5) 1 11.8 H	MS6_1 (6) 2 12.8 H	MS6_3 (12) 2 13.6 H	MS6_4 (11) 2 11.4 FP
	< 1000	MS5_1 (4) 1 11.2 H	MS5_1 (7) 1 11.2 H	MS5_1 (6) 1 11.8 H	MS5_1 (7) 1 12.8 H	MS6_2 (10) 1 13.6 H	MS6_3 (21) 2 13.6 H	MS6_5 (15) 2 13.1 FP
	< 2000	MS5_1 (7) 1 11.2 H	MS5_1 (14) 1 11.2 H	MS6_1 (12) 2 12.8 H	MS6_2 (17) 2 13.6 H	MS6_3 (22) 2 14.5 H	MS6_4 (33) 2 15.1 H	
	< 3000	MS6_1 (11) 2 11.8 H	MS6_1 (16) 2 12.8 H	MS6_2 (18) 2 13.6 H	MS6_3 (20) 2 14.5 H	MS6_4 (27) 2 15.1 H	MS6_5 (42) 2 15.6 H	
	< 5000	MS6_1 (14) 2 12.8 H	MS6_2 (23) 2 13.6 H	MS6_3 (24) 2 14.5 H	MS6_4 (27) 2 15.1 H	MS6_4 (38) 2 15.1 H		

Legend:

Series	Drive Ratio	Mounting	Motor Code	HP/kW
Nettco MS	1	P	1	(0.5/0.37)
	5	Q	2	(0.75/.055)
	6	L	3	(1/0.75)
		S*	4	(1.5/1.1)
			5	(2/1.5)
			6	(3/2.2)
			8**	(0.5/.37)
			9**	(0.75-2/.55-1.5)
			10**	(3/2.2)

Tank height to diameter ratio 0.8 - 1.2

Liquids with Newtonian viscosity characteristics

S.G. difference of liquids < 0.1

Use for mild blending applications

Maximum density 1.10 g/cm³

Maximum viscosity ratio - 10:1 (>250cP)

Mixer in operation during filling and emptying

Example: Mi1Q2

*Direct Drive not available with seal.

** Air Motors

Chart Reference:

Model Design		
Blend Time (min.)		
No. Impeller	Impeller Dia. (in.)	Impeller Type

FP = FP-100, H = Hydrofoil

MIXER “BLEND TIME SELECTION TABLE”

50 HZ SELECTIONS

		VISCOSITY/cP or mPa-s						
		1	100	250	500	1000	2500	5000
TANK VOLUME / LITERS	< 100	MS1_1 (1) 1 104 FP	MS1_1 (1) 1 104 FP	MS1_1 (1) 1 104 FP	MS1_1 (1) 1 104 FP	MS1_1 (1) 1 97 FP	MS5_1 (2) 1 254 FP	MS5_1 (2) 1 226 FP
	< 250	MS1_1 (1) 1 104 FP	MS1_1 (1) 1 104 FP	MS1_1 (2) 1 104 FP	MS1_1 (2) 1 104 FP	MS5_1 (1) 1 325 H	MS5_1 (3) 1 254 FP	MS5_1 (3) 1 239 FP
	< 500	MS1_1 (2) 1 104 FP	MS1_1 (2) 1 104 FP	MS5_1 (1) 1 325 H	MS5_1 (1) 1 325 H	MS5_1 (3) 2 285 H	MS5_2 (4) 2 239 FP	MS5_2 (5) 2 226 FP
	< 1000	MS1_1 (4) 1 104 FP	MS5_1 (2) 1 325 H	MS5_1 (2) 1 325 H	MS5_1 (2) 1 325 H	MS5_1 (5) 2 285 H	MS5_3 (7) 2 325 H	MS5_3 (7) 2 239 FP
	< 1500	MS1_1 (5) 1 104 FP	MS5_1 (3) 1 325 H	MS5_1 (3) 1 325 H	MS5_1 (3) 1 325 H	MS5_1 (7) 2 285 H	MS5_3 (10) 2 325 H	MS5_3 (9) 2 239 FP
	< 2000	MS1_1 (7) 1 104 FP	MS5_1 (3) 1 325 H	MS5_1 (4) 1 325 H	MS5_1 (5) 1 325 H	MS5_1 (8) 2 285 H	MS5_3 (12) 2 325 H	MS5_4 (11) 2 267 FP
	< 2500	MS5_1 (3) 1 325 H	MS5_1 (5) 1 325 H	MS5_1 (5) 1 325 H	MS5_1 (5) 1 325 H	MS5_2 (7) 1 368 H	MS5_3 (16) 2 325 H	MS5_5 (11) 2 290 FP
	< 3750	MS5_1 (4) 1 325 H	MS5_1 (7) 1 325 H	MS5_1 (6) 1 325 H	MS5_1 (7) 1 325 H	MS5_2 (10) 1 368 H	MS5_3 (21) 2 325 H	MS5_5 (15) 2 290 FP
	< 5000	MS5_1 (5) 1 325 H	MS5_1 (9) 1 325 H	MS5_1 (9) 2 300 H	MS5_2 (13) 2 325 H	MS5_3 (14) 2 345 H	MS5_4 (26) 2 345 H	
	< 7500	MS5_1 (6) 1 325 H	MS5_1 (14) 1 325 H	MS5_1 (13) 2 300 H	MS5_2 (17) 2 325 H	MS5_3 (23) 2 345 H	MS5_4 (37) 2 345 H	
	< 10000	MS5_1 (8) 1 325 H	MS5_1 (17) 2 300 H	MS5_2 (14) 2 325 H	MS5_3 (18) 2 25 H	MS5_4 (24) 2 368 H	MS5_5 (37) 2 384 H	
	< 12500	MS5_1 (11) 2 300 H	MS5_2 (17) 2 325 H	MS5_3 (18) 2 325 H	MS5_4 (20) 2 384 H	MS5_4 (28) 2 368 H		
	< 15000	MS5_1 (12) 2 300 H	MS5_2 (21) 2 325 H	MS5_3 (20) 2 325 H	MS5_4 (22) 2 384 H	MS5_4 (32) 2 368 H		
	< 20000	MS5_1 (16) 2 300 H	MS5_2 (27) 2 325 H	MS5_3 (23) 2 325 H				

Chart Reference:

Model Design		
Blend Time (min.)		
No. Impeller	Impeller Dia. (mm)	Impeller Type

FP = FP-100, H = Hydrofoil

Nettco S-Series Mixers

SANITARY STAINLESS STEEL
PORTABLE/FIXED MOUNT
MIXERS

SPX INDUSTRIAL PROCESSES

MULTIPLE IMPELLER STYLES:



PBT Impeller:

For low-to-medium viscosity flow controlled applications. Although superseded by the Hydrofoil, the PBT still has a specific role in applications where a degree of fluid shear is beneficial to the overall process result.

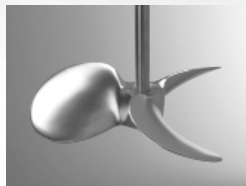

FP 100 Impeller (Marine Prop):

Recommended for applications requiring moderate pumping action and powder-wetting capabilities.



Hydrofoil Impeller:

For low viscosity flow controlled applications. Combines performance and high flow efficiency not found in other axial flow impellers.

GEAR DRIVE MIXER REPAIR KIT:

- Service kits available for rapid replacement of routine service items.

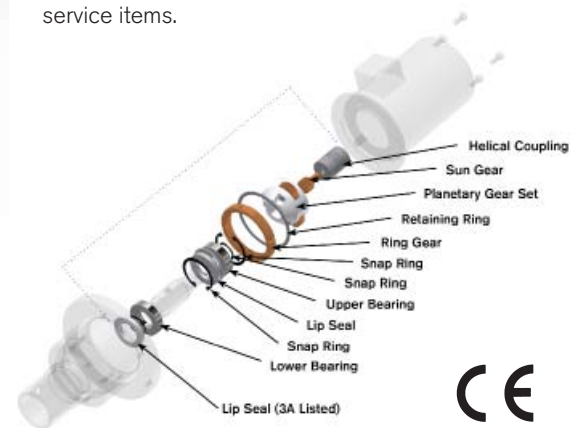

Global locations

USA

SPX GLOBAL HEADQUARTERS

13515 Ballantyne Corporate Place
Charlotte, NC 28277
United States of America
+1 704 752 4400

SPX FLOW TECHNOLOGY

135 Mt. Read Blvd.
Rochester, NY 14611
P: (888) 649-2378 (MIX-BEST), US and Canada) or +1 (585) 436-5550
F: (585) 436-5589
E: lightnin@spx.com ▪ www.lightninmixers.com

APAC

SPX ASIA PACIFIC

2F, Treasury Building
1568 Hua Shan Road
Shanghai 20000523
Peoples Republic of China
+86 21 2208 5888

EMEA

SPX EUROPE

Ocean House
Towers Business Park
Wilmslow Road
Manchester, M20 2LY England
+44 (0) 161 2491170

SPX reserves the right to incorporate our latest design and material changes without notice or obligation.

Design features, materials of construction and dimensional data, as described in this bulletin, are provided for your information only and should not be relied upon unless confirmed in writing. Please contact your local sales representative for product availability in your region. For more information visit www.spx.com.

The green ">" is a trademark of SPX Corporation, Inc.

ISSUED 07/2015 B-933

COPYRIGHT © 2015 SPX Corporation